

Trinkwasserspeicher für Wärmepumpe
Domestic hot water tank for heat pump
Ballon eau chaude sanitaire pour pompe à chaleur
Serbatoio di accumulo acqua calda sanitaria per pompa di calore
WPS/C 500 – 2000

Edelstahl
 Stainless steel | Acier inoxydable | Acciaio inossidabile

DIN
 EN 12897
 EnEV 730.02
 ErP 812/2013
 ErP 814/2013
 DIN 4753

SVGW
SSIGE

CE



Bauart
 Design | Structure | Struttura

Die Speicher sind aus hochwertigem Edelstahl V4A gefertigt.
 Die Speicher werden nach EN 12897:2014 dimensioniert, gefertigt und zertifiziert.

EN The storage tanks are made from high quality stainless steel (V4A). The storage tanks are designed, manufactured and certified in accordance with EN 12897:2014.

FR Les ballons sont fabriqués en acier inoxydable au molybdène de grande qualité. Les ballons sont dimensionnés, fabriqués et certifiés selon la norme EN 12897:2014.

IT Gli accumulatori sono realizzati in pregiato acciaio inossidabile V4A. Gli accumulatori sono dimensionati, costruiti e certificati secondo la norma EN 12897:2014.

Lieferumfang
 Delivery | Livraison | Consegna

	l	mm		Art. Nr.
Bedienungsanleitung Operation manual Mode d'emploi Istruzioni per l'uso			1 x	
Thermometer mit Tauchhülse Thermometer with immersion sleeve Thermomètre avec manchon d'immersion Termometro con manicotto ad immersione	≤ 600	100	1 x	6001160100
	≥ 800	200	1 x	6001160200
Tauchhülse Immersion sleeve Manchon d'immersion Manicotto ad immersione		1000	1 x	6001191011



WPS/C 500 – 2000

Schutz vor Korrosion

Anti-corrosion protection | Protection contre la corrosion | Protezione anticorrosiva

Behälter vollständig tauchgebeizt und passiviert. Hochwertiger, dickwandiger Edelstahl V4A.

EN Water tanks completely pickled by immersion and passivated. High-quality stainless steel V4A with thick walls.

FR Réservoirs intégralement décapés par immersion et passivés. Tôle épaisse en acier inoxydable V4A haut de gamme.

IT Serbatoio interamente decapato a immersione e passivato. Pregiato acciaio inox V4A di notevole spessore.

Wärmetauscher

Heat exchanger | Échangeur de chaleur | Scambiatore di calore

Zwei eingeschweisste grossflächige Wärmetauscher.

EN Two welded large-surface heat exchangers.

FR Deux échangeurs de chaleur grande surface soudés.

IT Due scambiatori di calore di grande superficie saldati.

Isolierung

Insulation | Isolation | Isolamento

PU-Hartschaum

60 mm PU-Hartschaum fix geschäumt. Skaimantel 5 mm mit Reissverschluss vormontiert, inklusive Rosetten und Abdeckhaube. Brandschutzklasse B2. Silber. Weitere Farben nach Absprache.

UltraShell

Mehrschicht-Isolierung aus 80 mm Hartschaum + 20 mm Faservlies. PS-Mantel und Hakenleiste, inklusive Rosetten und Abdeckhaube. Brandschutzklasse B2. Silber. Lose geliefert.

EN Rigid polyurethane foam

60 mm rigid polyurethane foam. Skai jacket 5 mm with zip preassembled, including cover plates and hood. Fire-resistance rating B2. Silver. Other colours on request.

FR Mousse solidifiée PU

60 mm de mousse dure PU Enveloppe en skai de 5 mm préinstallée avec fermeture à glissière, y compris rosettes et capot. Classe allemande de protection incendie B2. Argent. Autres couleurs après concertation

IT Schiuma PU rigida

60 mm di schiuma rigida di poliuretano fissa. Mantello in skai da 5 mm pre-assemblato con cerniera, dotato di rosette e calotta di copertura. Classe di resistenza antincendio B2. Argent. Altri colori su richiesta.

UltraShell

Multilayer insulation made of 80 mm rigid foam + 20 mm fibre fleece. PS jacket and hook rack, including cover plates and hood. Fire-resistance rating B2. Silver. Supplied loose.

UltraShell

Isolation multicouches constituée de 80 mm de mousse dure + 20 mm de tissu fibreux. Enveloppe en PS équipée d'un support à crochets préinstallé, y compris rosettes et capot. Classe allemande de protection incendie B2. Argent. Livrée non montée.

UltraShell

Isolamento multistrato con 80 mm di schiuma rigida + 20 mm di tessuto non tessuto. Mantello in PS e barra con ganci, rosette e calotta di copertura incluse. Classe di resistenza antincendio B2. Argent. Consegna sfusa.

≤ 600 L
PU-Hartschaum

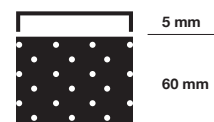

800 – 2000 L
UltraShell

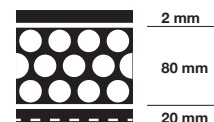

Trinkwasserspeicher für Wärmepumpe
Domestic hot water tank for heat pump
Ballon eau chaude sanitaire pour pompe à chaleur
Serbatoio di accumulo acqua calda sanitaria per pompa di calore
WPS/C 500 – 2000

Edelstahl
 Stainless steel | Acier inoxydable | Acciaio inossidabile

Typ WPS/C		500	600	800	1000	1250	1500	1750	2000
Inhalt Capacity Contenance Contenuto	l	498	562	830	925	1226	1413	1728	1926
Ø mit Isolierung with insulation avec isolation con isolamento	mm	750	750	990	990	1100	1200	1300	1300
Ø ohne Isolierung without insulation sans isolation senza isolamento	mm	-	-	790	790	900	1000	1100	1100
Höhe mit Isolierung Height with insulation Hauteur avec isolation Altezza con isolamento	mm	1800	2000	1990	2190	2240	2120	2150	2350
Kippmass Tilted dimension Cote de basculement Altezza in raddrizzamento	mm	1950	2140	1990	2190	2260	2120	2200	2355
Betriebsdruck Heizung Heater operating pressure Pression de service du chauffage Pressione d'esercizio riscaldamento	bar	6	6	6	6	6	6	6	6
Betriebsdruck Wasser Water operating pressure Pression de service de l'eau Pressione d'esercizio acqua	bar	6	6	6	6	6	6	6	6
Prüfdruck Test pressure Pression test Pressione di collaudo	bar	12	12	12	12	12	12	12	12
max. Betriebstemperatur max. operating temperature Temp. de service max. Temperatura max. d'esercizio	°C	95	95	95	95	95	95	95	95
Gewicht Weight Poids Peso	kg	204	241	288	340	415	423	466	521
Art.Nr. Part no. Réf. Art.n.	100205...	0500	0600	0800	1000	1250	1500	1750	2000
Isolierung Insulation Isolation Isolamento		60 mm fix eingeschäumt Fixed with foam Enrobage mousse fixe Schiuma rigida fissa		UltraShell 100					
Wärmeverlust Heat losses Pertes thermiques Perdita di calore	kWh/24h	1.89	2.03	3.26	3.44	3.6	3.77	4.01	4.38
ErP-Klasse ErP class Classe ErP Classe ErP		B	B	C	C	C	C	C	C
Gewicht Weight Poids Peso	kg	-	-	35	40	45	50	55	60
Art.Nr. Part no. Réf. Art.n.	300105...	-	-	0809	1009	1259	1509	1759	2009



WPS/C 500 – 2000

Typ WPS/C		500	600	800	1000	1250	1500	1750	2000
Glattrohrwärmetauscher unten Bottom heating coil Échangeurs de chaleur bas Serpentino inferiore	m ²	1.8	1.8	2.2	3.3	3.4	3.4	3.9	5.2
Inhalt Glattrohrwärmetauscher Heating coil capacity Contenance échangeurs de chaleur Contenuto serpentino	l	11.6	11.6	14.4	21.0	28.2	28.2	32.5	43.4
Durchflussmenge Throughput Débit Portata flusso	m ³ / h	3.0	3.0	3.7	5.5	5.7	5.7	6.5	8.7
Druckverlust Pressure loss Perte de charge Perdita di pressione	mbar	30	30	50	120	40	40	50	90
Dauerleistung Continuous output Régime permanent Potenza continua 10°C / 45°C / 80°C	l / h	861	861	1053	1579	1627	1627	1866	2488
max. Glattrohrwärmetauscherleistung max. heating coil output Puissance max. du échangeurs de chaleur Potenza max. serpentino	kW	35.0	35.0	42.8	64.3	66.2	66.2	76.0	101.3
Typ WPS/C		500	600	800	1000	1250	1500	1750	2000
Glattrohrwärmetauscher oben Top heating coil Échangeurs de chaleur haut Serpentino superiore	m ²	3.8	5.3	5.2	6.0	7.7	7.3	7.8	8.4
Inhalt Glattrohrwärmetauscher Heating coil capacity Contenance échangeurs de chaleur Contenuto serpentino	l	24.1	34.7	34.0	39.2	64.2	61.3	65.0	70.3
Durchflussmenge Throughput Débit Portata flusso	m ³ / h	1.0	1.3	1.1	1.3	1.7	1.6	1.7	1.8
Druckverlust Pressure loss Perte de charge Perdita di pressione	mbar	10	30	20	40	20	20	20	20
Dauerleistung Continuous output Régime permanent Potenza continua 10°C / 45°C / 50°C	l / h	244	342	319	368	491	442	491	516
max. Glattrohrwärmetauscherleistung max. heating coil output Puissance max. du échangeurs de chaleur Potenza max. serpentino	kW	10.0	13.0	13.0	15.0	20.0	18.0	20.0	21.0
Durchflussmenge Throughput Débit Portata flusso	m ³ / h	6.3	8.8	8.7	10.0	12.9	12.2	13.0	14.0
Druckverlust Pressure loss Perte de charge Perdita di pressione	mbar	220	550	400	640	330	230	310	330
Dauerleistung Continuous output Régime permanent Potenza continua 10°C / 45°C / 80°C	l / h	1819	2537	2488	2871	3685	3493	3733	4020
max. Glattrohrwärmetauscherleistung max. heating coil output Puissance max. du échangeurs de chaleur Potenza max. serpentino	kW	74.0	103.0	101.3	116.9	150.0	142.2	151.9	163.6

Trinkwasserspeicher für Wärmepumpe
Domestic hot water tank for heat pump
Ballon eau chaude sanitaire pour pompe à chaleur
Serbatoio di accumulo acqua calda sanitaria per pompa di calore
WPS/C 500 – 2000

Edelstahl
 Stainless steel | Acier inoxydable | Acciaio inossidabile

500 – 600

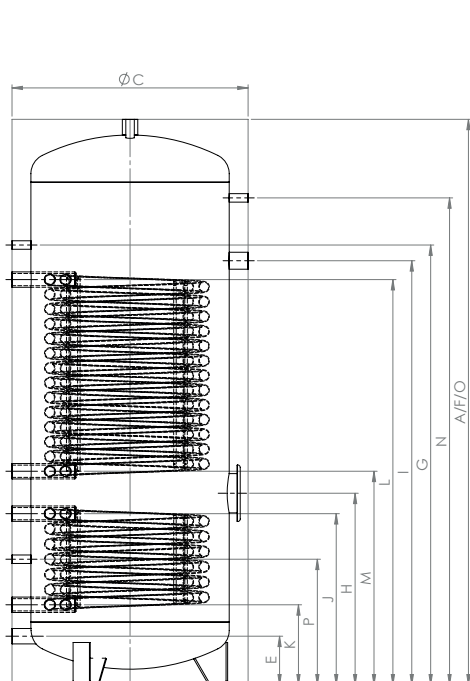

500

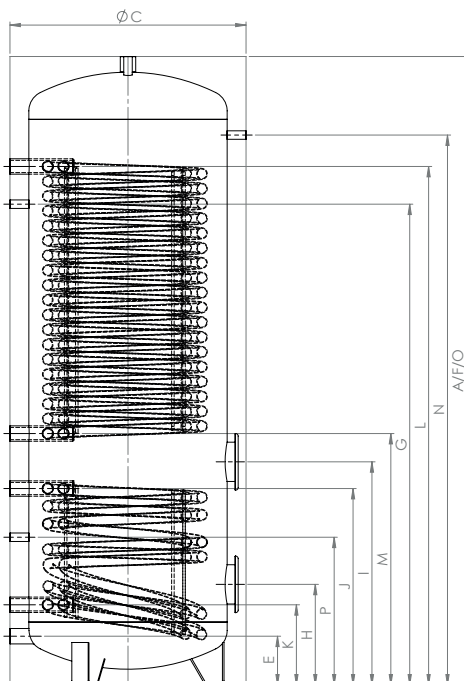

600

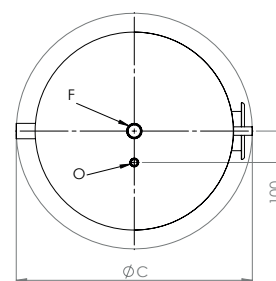

500 – 600



	Verwendung Usage Utilisation Uso	Dimension Dimension Dimension Dimensione	500	600
A	Höhe Height Hauteur Altezza	○ – mm	1800	2000
C	Ø	○ – mm	750	750
E	Kaltwasser Cold water Eau froide Acqua fredda	⇅ – mm	155	155
		G"	1 ¼"	1 ¼"
F	Warmwasser Hot water Eau chaude Acqua calda	⇅ – mm	1800	2000
		G"	1 ¼"	1 ¼"
G	Zirkulation Circulation Circulation Circolazione	⇅ – mm	1400	1530
		G"	½"	½"
H	Flansch unten Flange below Bride du bas Flangia inferiore	⇅ – mm	610	320
		Ø – mm	180/120	180/120
I	Flansch oben / Muffe E-Heizung Flange above / Sleeve electric heater Bride du haut / Manchon chauffage électrique Flangia superiore / Manicotto riscaldatore elettrico	⇅ – mm	1350	710
		Ø – mm	1 ½"	180/120
J	VL Glattrohrwärmetauscher unten Bottom heating coil Échangeurs de chaleur bas Serpentino inferiore	⇅ – mm	545	625
		G"	1 ¼"	1 ¼"
K	RL Glattrohrwärmetauscher unten Bottom heating coil Échangeurs de chaleur bas Serpentino inferiore	⇅ – mm	255	255
		G"	1 ¼"	1 ¼"
L	VL Glattrohrwärmetauscher oben Top heating coil Échangeurs de chaleur haut Serpentino superiore	⇅ – mm	1290	1650
		G"	1 ¼"	1 ¼"
M	RL Glattrohrwärmetauscher oben Top heating coil Échangeurs de chaleur haut Serpentino superiore	⇅ – mm	680	800
		G"	1 ¼"	1 ¼"
N	Thermometer Thermometer Thermomètre Termometro	⇅ – mm	1550	1750
		G"	½"	½"
O	Fühlerhülse Sensor sleeve Manchon de sonde Manicotto sensore	⇅ – mm	1800	2000
		G"	½"	½"
P	Fühler Sensor Sonde Sensor	⇅ – mm	400	470
		G"	½"	½"

Trinkwasserspeicher für Wärmepumpe
Domestic hot water tank for heat pump
Ballon eau chaude sanitaire pour pompe à chaleur
Serbatoio di accumulo acqua calda sanitaria per pompa di calore
WPS/C 500 – 2000

Edelstahl
Stainless steel | Acier inoxydable | Acciaio inossidabile

800 – 2000

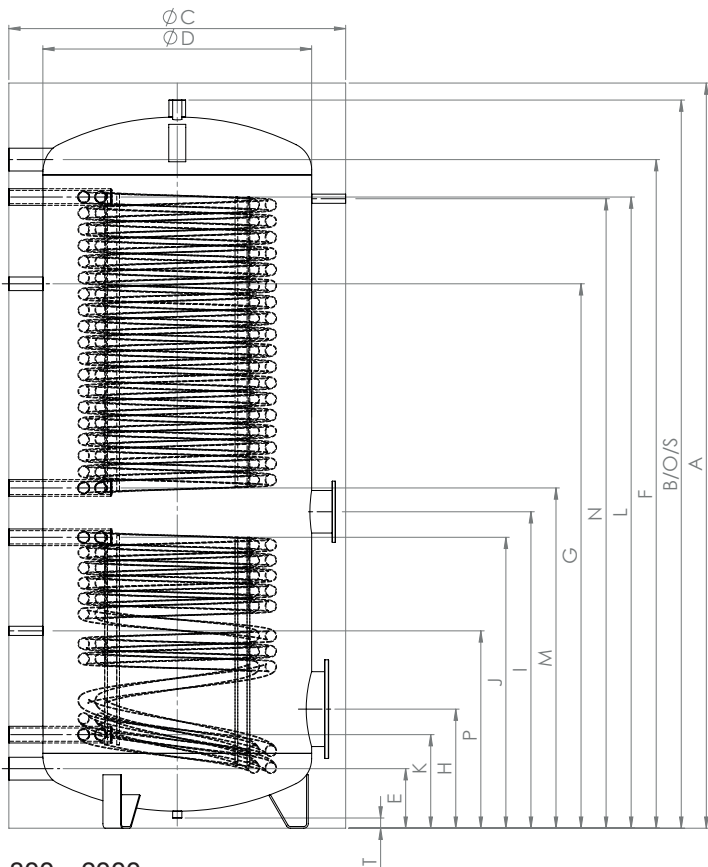

800 – 2000

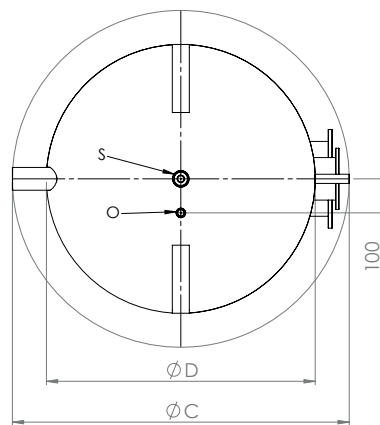

800 – 2000



	Verwendung Usage Utilisation Uso	Dimension Dimension Dimension Dimensione	800	1000	1250	1500	1750	2000
A	Höhe Height Hauteur Altezza	○ – mm	1990	2190	2240	2120	2150	2350
B		○ – mm	1940	2140	2190	2070	2100	2300
C	Ø	● – mm	990	990	1100	1200	1300	1300
D		○ – mm	790	790	900	1000	1100	1100
E	Kaltwasser Cold water Eau froide Acqua fredda	↕ – mm	175	175	200	220	235	235
		G" – mm	2"	2"	2"	2"	2"	2"
F	Warmwasser Hot water Eau chaude Acqua calda	↕ – mm	1765	1965	1990	1730	1730	1930
		G" – mm	2"	2"	2"	2"	2"	2"
G	Zirkulation Circulation Circulation Circolazione	↕ – mm	1400	1600	1600	1450	1400	1650
		G" – mm	1"	1"	1"	1"	1"	1"
H	Flansch unten Flange below Bride du bas Flangia inferiore	↕ – mm	350	350	400	470	480	480
		Ø – mm	290/220	290/220	290/220	290/220	290/220	290/220
I	Flansch oben Flange above Bride du haut Flangia superiore	↕ – mm	800	930	900	850	870	1000
		Ø – mm	180/120	180/120	180/120	180/120	180/120	180/120
J	VL Glatrohrwärmetauscher unten Bottom heating coil Échangeurs de chaleur bas Serpentino inferiore	↕ – mm	675	855	790	780	780	900
		G" – mm	1 ¼"	1 ¼"	1 ½"	1 ½"	1 ½"	1 ½"
K	RL Glatrohrwärmetauscher unten Bottom heating coil Échangeurs de chaleur bas Serpentino inferiore	↕ – mm	275	275	320	360	360	360
		G" – mm	1 ¼"	1 ¼"	1 ½"	1 ½"	1 ½"	1 ½"
L	VL Glatrohrwärmetauscher oben Top heating coil Échangeurs de chaleur haut Serpentino superiore	↕ – mm	1620	1855	1870	1600	1590	1790
		G" – mm	1 ¼"	1 ¼"	1 ½"	1 ½"	1 ½"	1 ½"
M	RL Glatrohrwärmetauscher oben Top heating coil Échangeurs de chaleur haut Serpentino superiore	↕ – mm	900	1000	1020	910	940	1090
		G" – mm	1 ¼"	1 ¼"	1 ½"	1 ½"	1 ½"	1 ½"
N	Thermometer Thermometer Thermomètre Termometro	↕ – mm	1650	1850	1900	1750	1750	1950
		G" – mm	½"	½"	½"	½"	½"	½"
O	Fühlerhülse Sensor sleeve Manchon de sonde Manicotto sensore	↕ – mm	1940	2140	2190	2070	2100	2300
		G" – mm	½"	½"	½"	½"	½"	½"
P	Fühler Sensor Sonde Sensor	↕ – mm	540	580	660	590	600	600
		G" – mm	½"	½"	½"	½"	½"	½"
S	Anschluss oben Connection top Lien ci-dessus Collegamento sopra	↕ – mm	1940	2140	2190	2070	2100	2300
		G" – mm	1 ¼"	1 ¼"	1 ¼"	1 ¼"	1 ¼"	1 ¼"
T	Bodenmuffe Ground fitting Manchon de fond Manicotto a pavimento	↕ – mm	30	30	30	30	30	30
		G" – mm	½"	½"	½"	1 ¼"	1 ¼"	1 ¼"