

ABS Weight OnTop

W-OT / W-OT-D

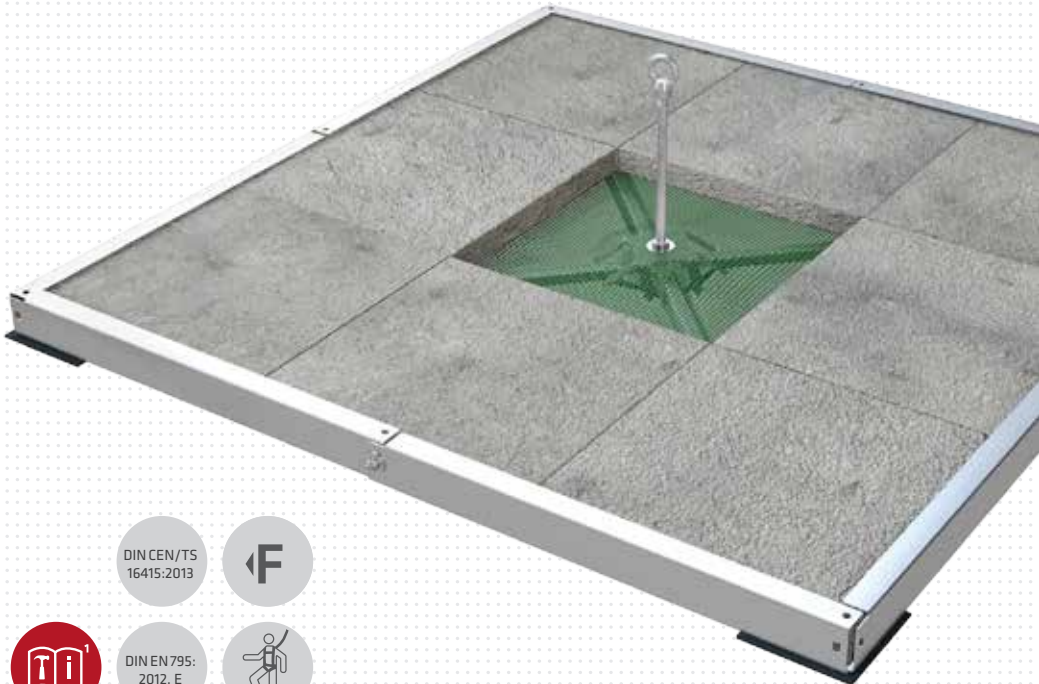

MoA 197-06

DIN CEN/TS
16415:2013



DIN EN 795:
2012, E



Werkzeuge | Tools

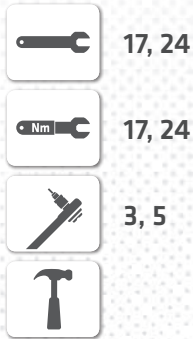

Sicherheitshinweise | Safety instructions



- DE** Die Anweisungen der Montageanleitung (1) und Sicherheitshinweise (2) sind strikt einzuhalten.
- EN** The information contained in the assembly instructions (1) and safety instructions (2) must be strictly observed.
- NL** De aanwijzingen in de montagehandleiding (1) en de veiligheidsvoorschriften (2) moeten strikt worden nageleefd.
- ES** Respete estrictamente las instrucciones del manual de montaje (1) y las indicaciones de seguridad (2).
- IT** È assolutamente necessario attenersi alle istruzioni di montaggio (1) e alle norme di sicurezza (2).
- FR** Les instructions de la notice de montage (1) et les consignes de sécurité (2) doivent être formellement respectées.
- PL** Należy ściśle przestrzegać instrukcji montażu (1) i wskazań bezpieczeństwa (2).
- DK** Montagevejledningens (1) anvisninger som også sikkerhedshenvisningerne (2) skal overholdes.
- CZ** Je nutné striktně dodržovat instrukce obsažené v montážním návodu (1) a v bezpečnostních pokynech (2).
- GR** Πρέπει να τηρούνται αυστηρά οι οδηγίες του χειριδίου συναρμολόγησης (1) και των υποδείξεων ασφαλείας (2).
- SK** Dôsledne dodržiavajte pokyny montážneho návodu (1) a bezpečnostné pokyny (2).
- TR** Montaj kılavuzunun (1) ve güvenliik uyarılarının talimatlarını (2) kesinlikle uyulmalıdır.
- NO** Det er svært viktig å instruksjonene i monteringshåndboken (1) og sikkerhetsheftet (2) følges.
- RUS** Необходимо строго соблюдать требования руководства по монтажу (1) и инструкции по безопасности (2).
- RO** Indicațiile din instrucțiunile de montare (1) și din broșura cu indicații de siguranță (2) trebuie respectate cu strictețe.
- FI** Asennusohjeen (1) ja turvaohjeihvikosen (2) ohjeita on ehdottomasti noudatettava.
- SE** Anvisningarna till monteringsanvisningen (1) och säkerhetsmanualen (2) måste iakttas under alla omständigheter.
- HI** इंस्ट्रक्शन के निर्देशों (1) और सुरक्षा निर्देश मैनुअल (2) में दिये गये निर्देशों का सख्ती से अनुसरण किया जाना चाहिए।
- ZH** 必须严格遵守装配说明书 (1) 和安全须知单 (2) 中的指示。
- SQ** Jëpb ialltrimat piallcekimetat e uardatave niall kërkitim (1) e kërkitim iarsadatat e siallmatave (2) bmetitave dëqat.

Kontakte | Contact persons

Vertrieb & Technische Beratung
Sales & Technical Support
+49 (0) 28 32 - 972 81 - 0
vertrieb@absturzicherung.de

Schulung
Training

+49 (0) 28 32 - 972 81 - 254
schulung@absturzicherung.de

Montagevorbereitung
Assembly

+49 (0) 28 32 - 972 81 - 260
service@absturzicherung.de

Mustertypenschild | Sample label

[ABS]

ABS SAFETY GMBH 3

Kevelaer, Germany
info@absturzicherung.de
www.absturzicherung.de

Mustertypenschild /
Sample only

Chargennummer /
Batch number

6 Normen / Standards

7 Max. Nutzer gleichzeitig (DIN EN 795:2012)
Max. No. of simultaneous users

11 Modellnummer / Model number

 -

 -

 -

-

 -

 -

 -

 -

 -

CE

0158

Z-14.9-688

9

10

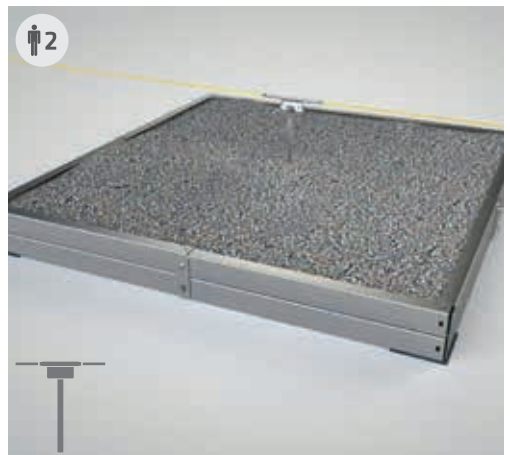
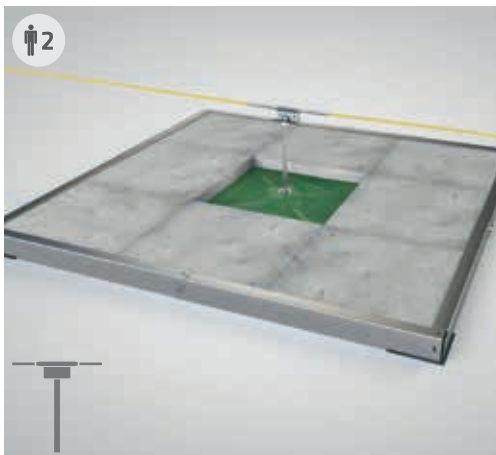
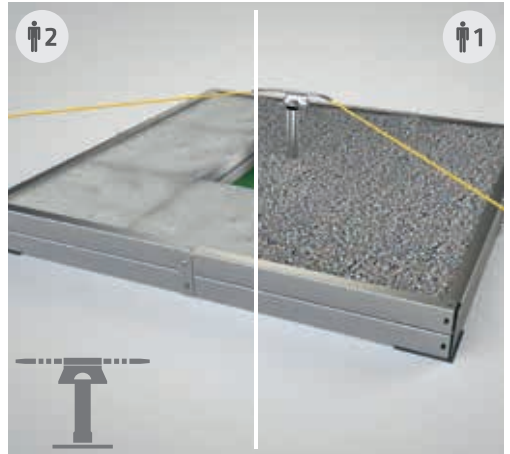
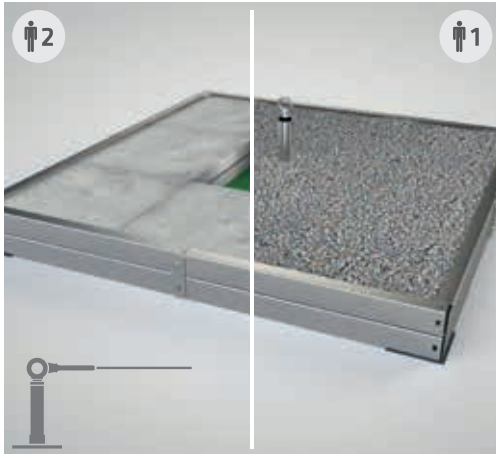
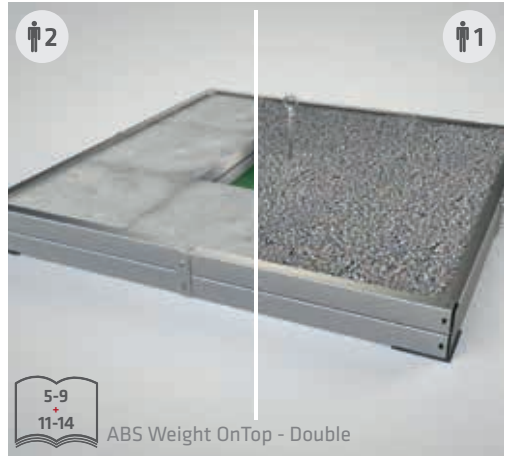
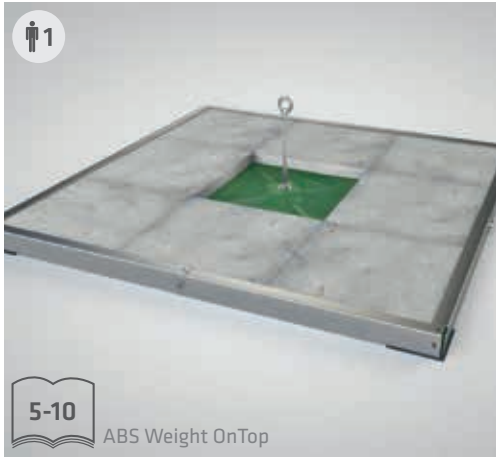

4 | ABS Weight OnTop
W-OT / W-OT-D

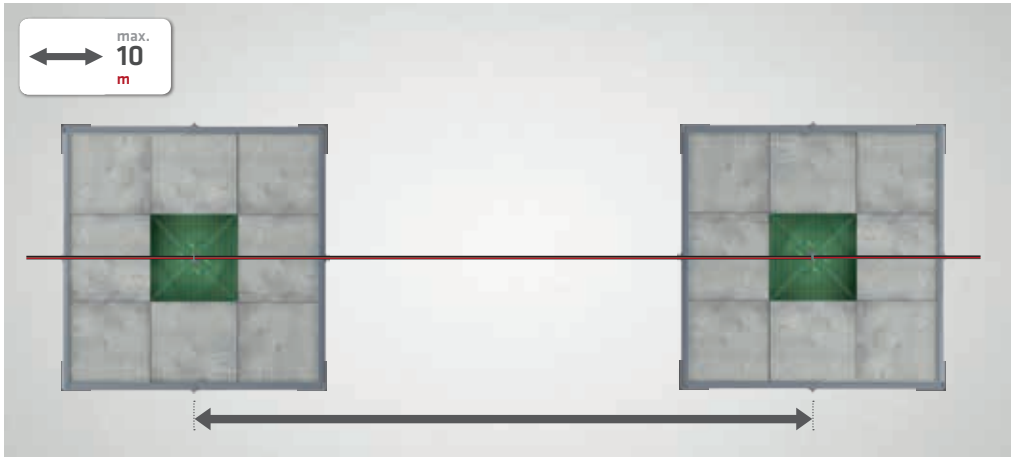
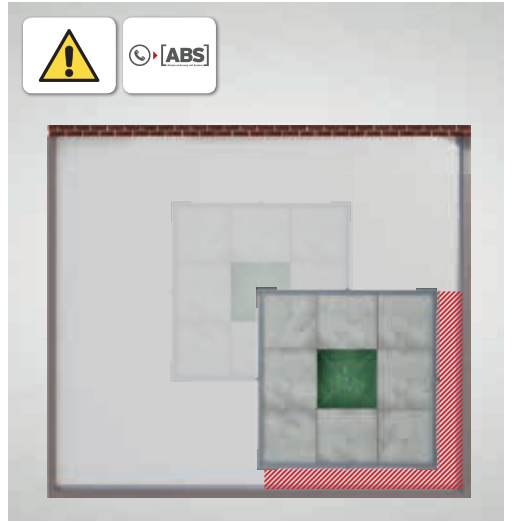
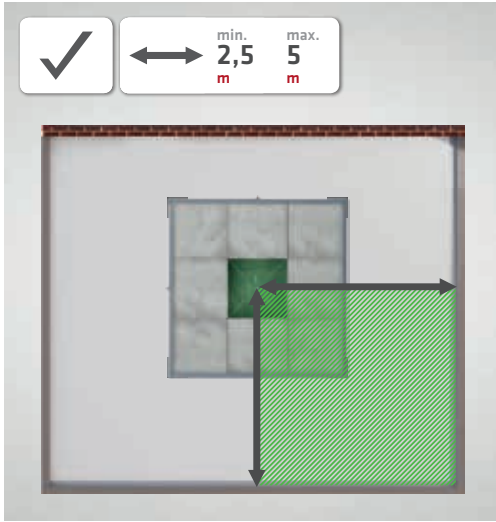



Muss auf der Dachhaut montiert werden
Must be installed on the roof membrane

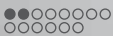
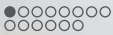



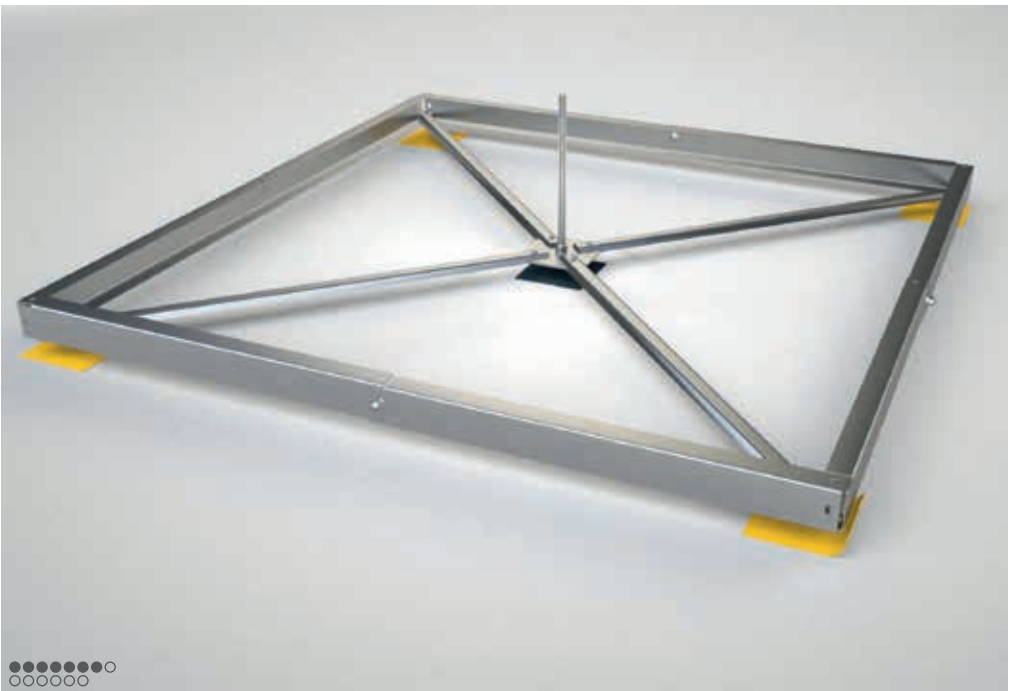
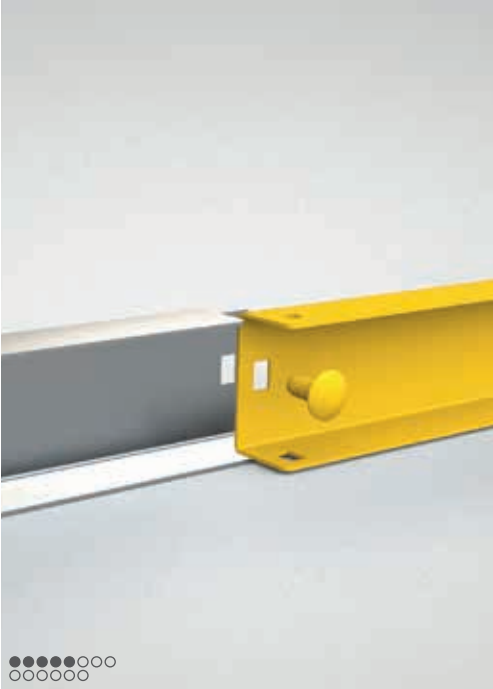



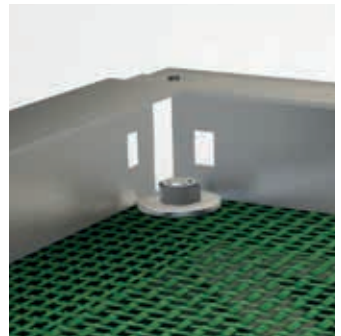
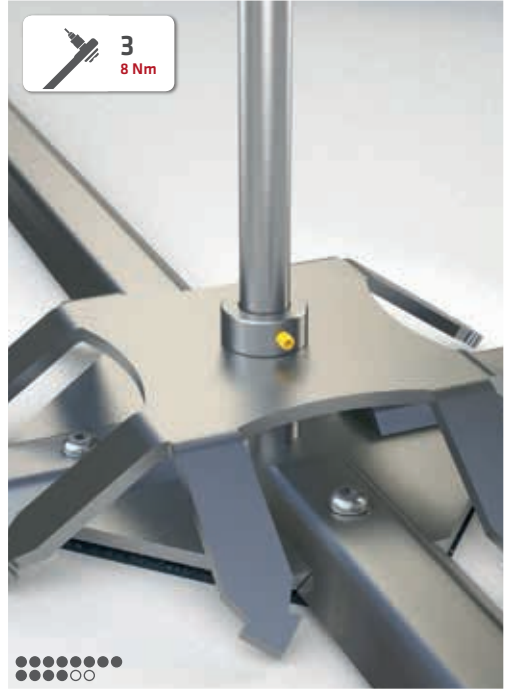

10 | ABS Weight OnTop
W-OT / W-OT-D

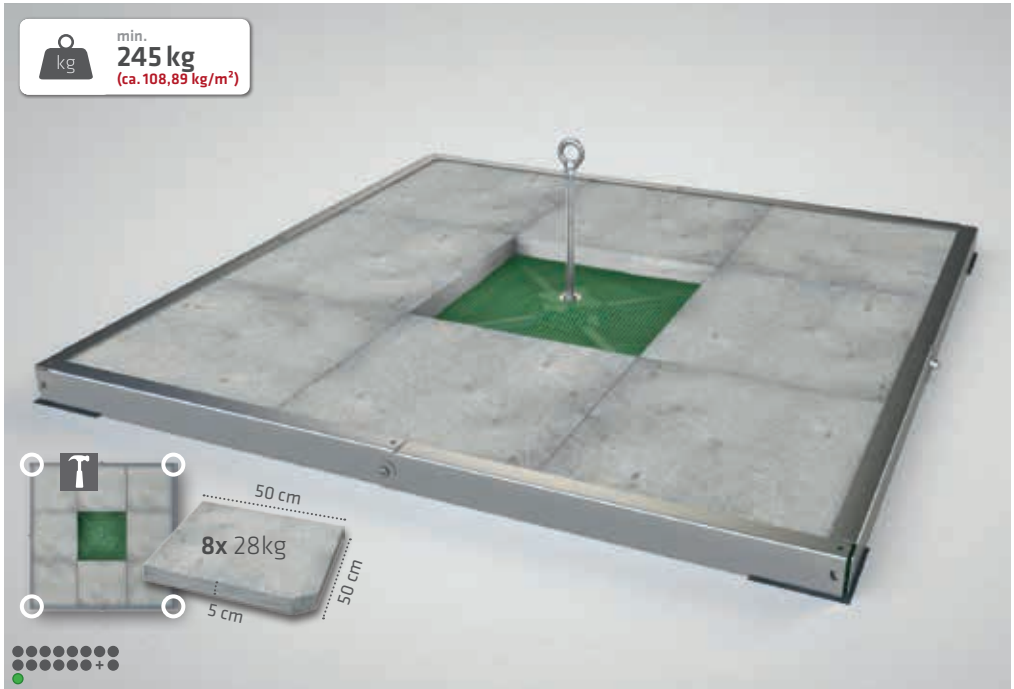

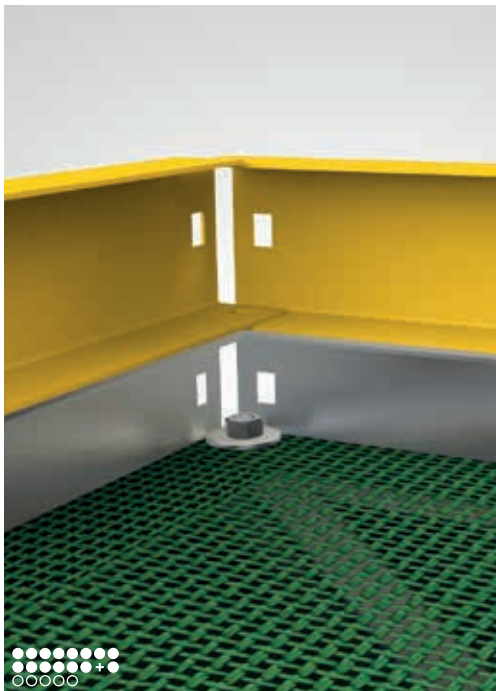
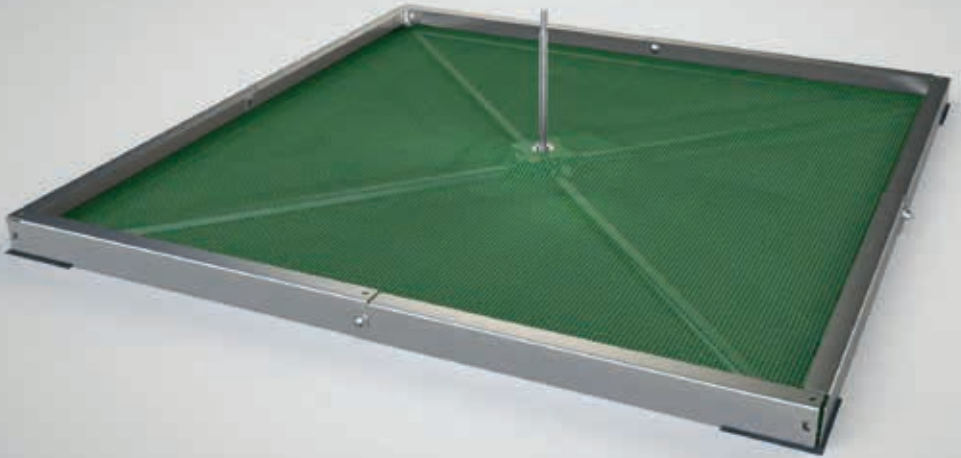

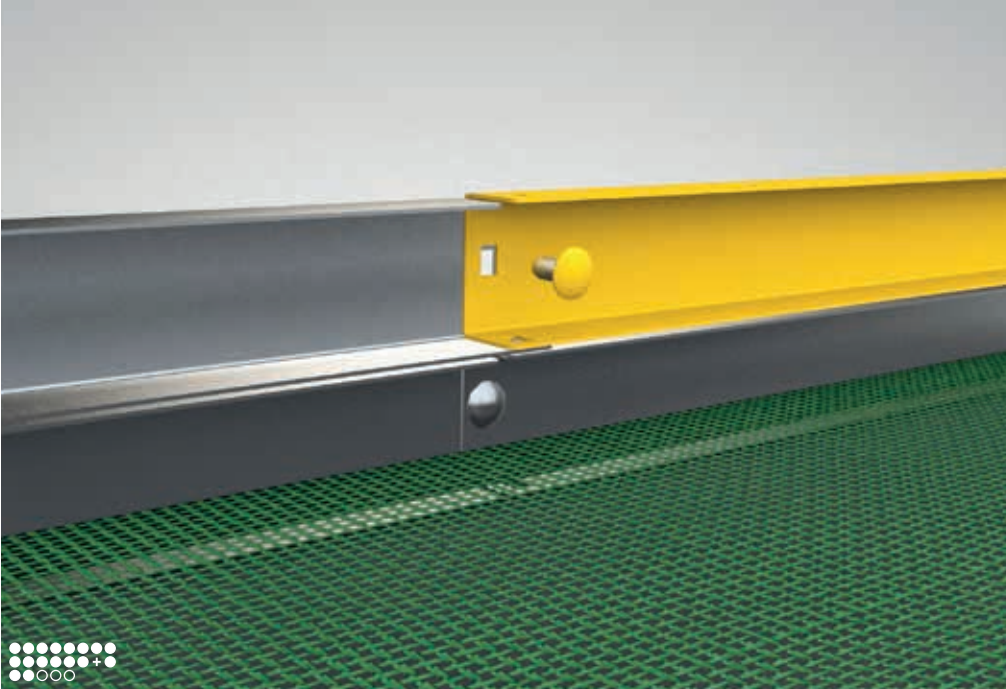



kg min.
483 kg
(ca. 214,67 kg/m²)

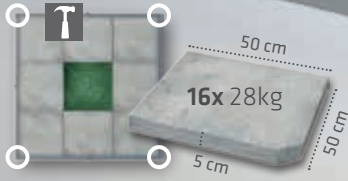
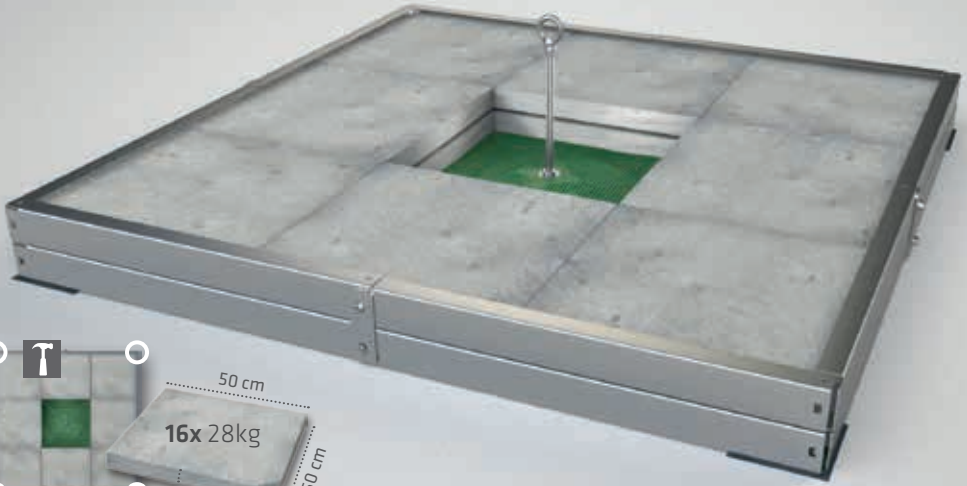

kg min.
450 kg
Kies / Gravel





MoA 098

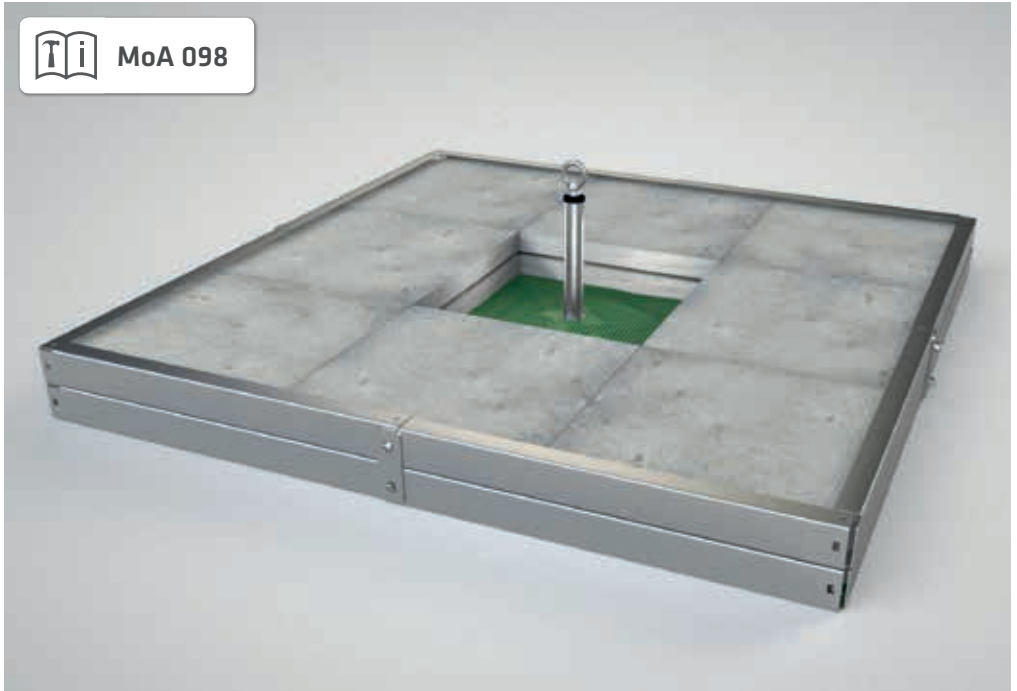

ALWAYS ON TOP!

ABS Safety GmbH

Gewerbering 3
D-47623 Kevelaer
Germany

Tel.: +49 (0) 28 32 - 972 81 - 0
Fax: +49 (0) 28 32 - 972 81 - 29

info@absturzsicherung.de

www.absturzsicherung.de
www.protection-anti-chute.fr
www.fall-arrest.eu

RS 77 Juni 2017



youtube.com/abssafetygmbh



facebook.com/ABS.Safety